

SUPPLY ARRANGEMENT FOR WORK SPACES

Category 3: Metal Filing & Storage Cabinets

NMSA # E60PQ-140003/043/PQ

Product Guide

Effective January 18, 2016

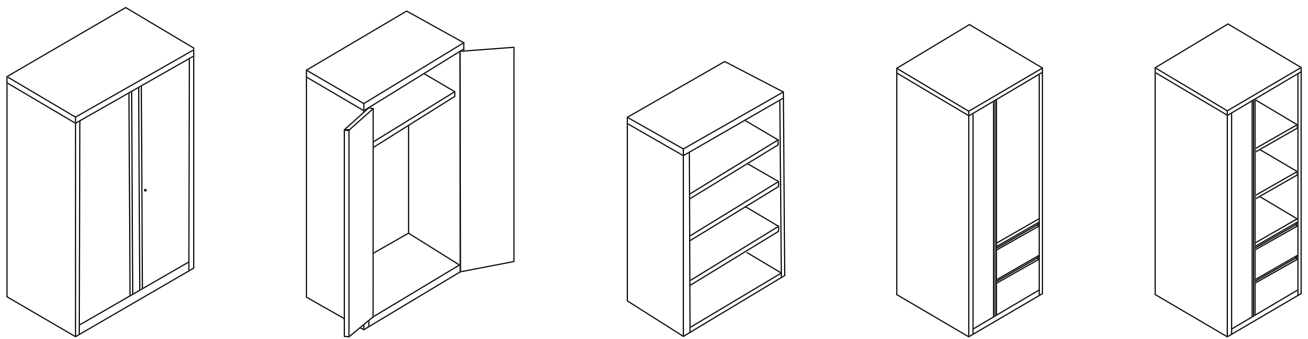
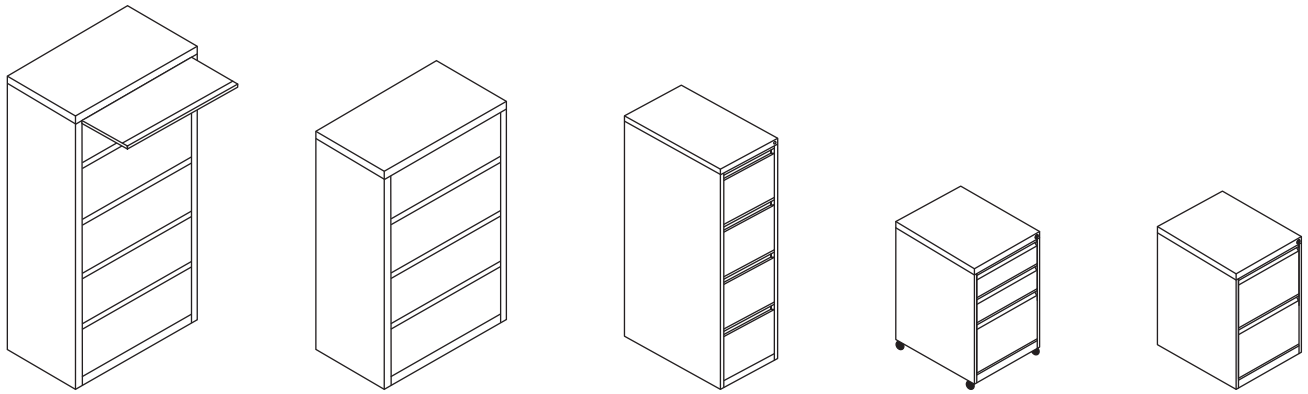

PERFIX INC.

450-435-0540
sales@perfix.ca
www.perfix.ca

SUPPLY ARRANGEMENT FOR WORKSPACES
NMSA # E60PQ-140003/043/PQ
Effective January 18, 2016

SERIES	PAGE
STORAGE CABINETS / WARDROBE CABINETS	3
OPEN WARDROBE CABINETS	4
OPEN BOOKCASES	5
LOCKING LATERAL FILING CABINETS	6
LOCKING VERTICAL FILING CABINETS.	7
PERSONAL STORAGE TOWERS	9
PEDESTALS (ON CASTERS).	10
PEDESTALS (ON GLIDES)	11

DELIVERIES

2 - 4 weeks.

COLOR FINISHES

12 standard colors, please refer to color chart.

TRANSPORTATION

Extra, F.O.B, our factory Boisbriand, Qc.
Please contact our Customer Service Department for Freight quote.

INSTALLATION

Extra, Please contact our Customer Service Department for Installation quote.

PRICING

Price upon request.



STORAGE CABINETS

HINGED DOORS

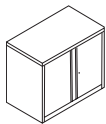
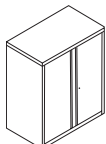
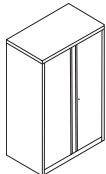
MODEL	DESCRIPTION	GOVERNMENT GoCUIC	WIDTH " (mm)	DEPTH " (mm)	HEIGHT " (mm)	PERFIX CODE	CEILING PRICE \$
	Two-door storage cabinet 1 shelf	SCSC2DSCxxx18362433	36 (914)	18 (457)	27 ⁷ / ₈ (708)	20-1-361824	-
		SCSC2DSCxxx20362433	36 (914)	20 (508)	27 ⁷ / ₈ (708)	20-1-362024	-
		SCSC2DSCxxx24362433	36 (914)	24 (610)	27 ⁷ / ₈ (708)	20-1-362424	-
		SCSC2DSCxxx18422433	42 (1067)	18 (457)	27 ⁷ / ₈ (708)	20-1-421824	-
		SCSC2DSCxxx20422433	42 (1067)	20 (508)	27 ⁷ / ₈ (708)	20-1-422024	-
		SCSC2DSCxxx24422433	42 (1067)	24 (610)	27 ⁷ / ₈ (708)	20-1-422424	-
	Two-door storage cabinet 2 shelves	SCSC2DSCxxx18363443	36 (914)	18 (457)	40 ¹ / ₁₆ (1018)	20-2-361836	-
		SCSC2DSCxxx20363443	36 (914)	20 (508)	40 ¹ / ₁₆ (1018)	20-2-362036	-
		SCSC2DSCxxx24363443	36 (914)	24 (610)	40 ¹ / ₁₆ (1018)	20-2-362436	-
		SCSC2DSCxxx18423443	42 (1067)	18 (457)	40 ¹ / ₁₆ (1018)	20-2-421836	-
		SCSC2DSCxxx20423443	42 (1067)	20 (508)	40 ¹ / ₁₆ (1018)	20-2-422036	-
		SCSC2DSCxxx24423443	42 (1067)	24 (610)	40 ¹ / ₁₆ (1018)	20-2-422436	-
	Two-door storage cabinet 3 shelves	SCSC2DSCxxx18364454	36 (914)	18 (457)	53 ³ / ₈ (1356)	20-3-361848	-
		SCSC2DSCxxx20364454	36 (914)	20 (508)	53 ³ / ₈ (1356)	20-3-362048	-
		SCSC2DSCxxx24364454	36 (914)	24 (610)	53 ³ / ₈ (1356)	20-3-362448	-
		SCSC2DSCxxx18424454	42 (1067)	18 (457)	53 ³ / ₈ (1356)	20-3-421848	-
		SCSC2DSCxxx20424454	42 (1067)	20 (508)	53 ³ / ₈ (1356)	20-3-422048	-
		SCSC2DSCxxx24424454	42 (1067)	24 (610)	53 ³ / ₈ (1356)	20-3-422448	-

WARDROBE CABINETS

HINGED DOORS

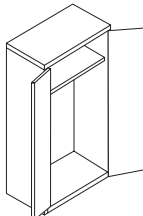
	Two-door wardrobe cabinet 1 shelf 1 coat rod	WARD2DSCxxx20364454	36 (914)	20 (508)	53 ³ / ₈ (1356)	20-W-809-362048	-
		WARD2DSCxxx24364454	36 (914)	24 (610)	53 ³ / ₈ (1356)	20-W-809-362448	-
		WARD2DSCxxx20424454	42 (1067)	20 (508)	53 ³ / ₈ (1356)	20-W-809-422048	-
		WARD2DSCxxx24424454	42 (1067)	24 (610)	53 ³ / ₈ (1356)	20-W-809-422448	-

OPEN WARDROBE CABINETS

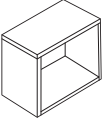
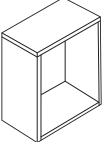
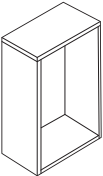
MODEL	DESCRIPTION	GOVERNMENT GoCUIC	WIDTH " (mm)	DEPTH " (mm)	HEIGHT " (mm)	PERFIX CODE	CEILING PRICE \$
	Open wardrobe cabinet 1 coat rod	WARDOPSCxxx18302433	30 (762)	18 (457)	27 ⁷ / ₈ (708)	20-809-301824	—
		WARDOPSCxxx18362433	36 (914)	18 (457)	27 ⁷ / ₈ (708)	20-809-361824	—
		WARDOPSCxxx18422433	42 (1067)	18 (457)	27 ⁷ / ₈ (708)	20-809-421824	—
		WARDOPSCxxx18482433	48 (1219)	18 (457)	27 ⁷ / ₈ (708)	20-809-481824	—
		WARDOPSCxxx20302433	30 (762)	20 (508)	27 ⁷ / ₈ (708)	20-809-302024	—
		WARDOPSCxxx20362433	36 (914)	20 (508)	27 ⁷ / ₈ (708)	20-809-362024	—
		WARDOPSCxxx20422433	42 (1067)	20 (508)	27 ⁷ / ₈ (708)	20-809-422024	—
		WARDOPSCxxx20482433	48 (1219)	20 (508)	27 ⁷ / ₈ (708)	20-809-482024	—
	Open wardrobe cabinet 1 coat rod	WARDOPSCxxx18303443	30 (762)	18 (457)	40 ¹ / ₁₆ (1018)	20-809-301836	—
		WARDOPSCxxx18363443	36 (914)	18 (457)	40 ¹ / ₁₆ (1018)	20-809-361836	—
		WARDOPSCxxx18423443	42 (1067)	18 (457)	40 ¹ / ₁₆ (1018)	20-809-421836	—
		WARDOPSCxxx18483443	48 (1219)	18 (457)	40 ¹ / ₁₆ (1018)	20-809-481836	—
		WARDOPSCxxx20303443	30 (762)	20 (508)	40 ¹ / ₁₆ (1018)	20-809-302036	—
		WARDOPSCxxx20363443	36 (914)	20 (508)	40 ¹ / ₁₆ (1018)	20-809-362036	—
		WARDOPSCxxx20423443	42 (1067)	20 (508)	40 ¹ / ₁₆ (1018)	20-809-422036	—
		WARDOPSCxxx20483443	48 (1219)	20 (508)	40 ¹ / ₁₆ (1018)	20-809-482036	—
	Open wardrobe cabinet 1 coat rod	WARDOPSCxxx18304454	30 (762)	18 (457)	53 ³ / ₈ (1356)	20-809-301848	—
		WARDOPSCxxx18364454	36 (914)	18 (457)	53 ³ / ₈ (1356)	20-809-361848	—
		WARDOPSCxxx18424454	42 (1067)	18 (457)	53 ³ / ₈ (1356)	20-809-421848	—
		WARDOPSCxxx18484454	48 (1219)	18 (457)	53 ³ / ₈ (1356)	20-809-481848	—
		WARDOPSCxxx20304454	30 (762)	20 (508)	53 ³ / ₈ (1356)	20-809-302048	—
		WARDOPSCxxx20364454	36 (914)	20 (508)	53 ³ / ₈ (1356)	20-809-362048	—
		WARDOPSCxxx20424454	42 (1067)	20 (508)	53 ³ / ₈ (1356)	20-809-422048	—
		WARDOPSCxxx20484454	48 (1219)	20 (508)	53 ³ / ₈ (1356)	20-809-482048	—

OPEN BOOKCASES

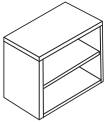
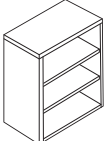
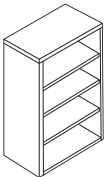
MODEL	DESCRIPTION	GOVERNMENT GoCUIC	WIDTH " (mm)	DEPTH " (mm)	HEIGHT " (mm)	PERFIX CODE	CEILING PRICE \$
	Open bookcase 1 shelf	SCSCOPSCxxx18302433	30 (762)	18 (457)	27 ⁷ / ₈ (708)	12-1-301824	-
		SCSCOPSCxxx18362433	36 (914)	18 (457)	27 ⁷ / ₈ (708)	12-1-361824	-
		SCSCOPSCxxx18422433	42 (1067)	18 (457)	27 ⁷ / ₈ (708)	12-1-421824	-
		SCSCOPSCxxx18482433	48 (1219)	18 (457)	27 ⁷ / ₈ (708)	12-1-481824	-
		SCSCOPSCxxx20302433	30 (762)	20 (508)	27 ⁷ / ₈ (708)	12-1-302024	-
		SCSCOPSCxxx20362433	36 (914)	20 (508)	27 ⁷ / ₈ (708)	12-1-362024	-
		SCSCOPSCxxx20422433	42 (1067)	20 (508)	27 ⁷ / ₈ (708)	12-1-422024	-
		SCSCOPSCxxx20482433	48 (1219)	20 (508)	27 ⁷ / ₈ (708)	12-1-482024	-
	Open bookcase 2 shelves	SCSCOPSCxxx18303443	30 (762)	18 (457)	40 ¹ / ₁₆ (1018)	12-2-301836	-
		SCSCOPSCxxx18363443	36 (914)	18 (457)	40 ¹ / ₁₆ (1018)	12-2-361836	-
		SCSCOPSCxxx18423443	42 (1067)	18 (457)	40 ¹ / ₁₆ (1018)	12-2-421836	-
		SCSCOPSCxxx18483443	48 (1219)	18 (457)	40 ¹ / ₁₆ (1018)	12-2-481836	-
		SCSCOPSCxxx20303443	30 (762)	20 (508)	40 ¹ / ₁₆ (1018)	12-2-302036	-
		SCSCOPSCxxx20363443	36 (914)	20 (508)	40 ¹ / ₁₆ (1018)	12-2-362036	-
		SCSCOPSCxxx20423443	42 (1067)	20 (508)	40 ¹ / ₁₆ (1018)	12-2-422036	-
		SCSCOPSCxxx20483443	48 (1219)	20 (508)	40 ¹ / ₁₆ (1018)	12-2-482036	-
	Open bookcase 3 shelves	SCSCOPSCxxx18304454	30 (762)	18 (457)	53 ³ / ₈ (1356)	12-3-301848	-
		SCSCOPSCxxx18364454	36 (914)	18 (457)	53 ³ / ₈ (1356)	12-3-361848	-
		SCSCOPSCxxx18424454	42 (1067)	18 (457)	53 ³ / ₈ (1356)	12-3-421848	-
		SCSCOPSCxxx18484454	48 (1219)	18 (457)	53 ³ / ₈ (1356)	12-3-481848	-
		SCSCOPSCxxx20304454	30 (762)	20 (508)	53 ³ / ₈ (1356)	12-3-302048	-
		SCSCOPSCxxx20364454	36 (914)	20 (508)	53 ³ / ₈ (1356)	12-3-362048	-
		SCSCOPSCxxx20424454	42 (1067)	20 (508)	53 ³ / ₈ (1356)	12-3-422048	-
		SCSCOPSCxxx20484454	48 (1219)	20 (508)	53 ³ / ₈ (1356)	12-3-482048	-

LOCKING LATERAL FILING CABINETS

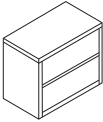
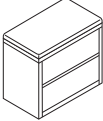
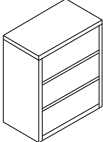
MODEL	DESCRIPTION	GOVERNMENT GoCUIC	WIDTH " (mm)	DEPTH " (mm)	HEIGHT " (mm)	PERFIX CODE	CEILING PRICE \$
	Lateral file Two (2) fixed front drawers	LLFC2Dxxxxx1830xxxx	30 (762)	18 (457)	27 ⁷ / ₈ (708)	2021-33-30	—
		LLFC2Dxxxxx2030xxxx	30 (762)	20 (508)	27 ⁷ / ₈ (708)	2021-600-302024	—
		LLFC2DFDxxx1836xxxx	36 (914)	18 (457)	27 ⁷ / ₈ (708)	2021-33-36	—
		LLFC2DFDxxx2036xxxx	36 (914)	20 (508)	27 ⁷ / ₈ (708)	2021-600-362024	—
		LLFC2DFDxxx1842xxxx	42 (1067)	18 (457)	27 ⁷ / ₈ (708)	2021-33-42	—
		LLFC2DFDxxx2042xxxx	42 (1067)	20 (508)	27 ⁷ / ₈ (708)	2021-600-422024	—
	Lateral file Two (2) fixed front drawers with cushion top	LLFC2DCTxxx1830xxxx	30 (762)	18 (457)	27 ⁷ / ₈ (708)	2021-609-301824	—
		LLFC2DCTxxx2030xxxx	30 (762)	20 (508)	27 ⁷ / ₈ (708)	2021-609-302024	—
		LLFC2DFCTxx1836xxxx	36 (914)	18 (457)	27 ⁷ / ₈ (708)	2021-609-361824	—
		LLFC2DFCTxxx2036xxxx	36 (914)	20 (508)	27 ⁷ / ₈ (708)	2021-609-362024	—
		LLFC2DFCTxxx1842xxxx	42 (1067)	18 (457)	27 ⁷ / ₈ (708)	2021-609-421824	—
		LLFC2DFCTxxx2042xxxx	42 (1067)	20 (508)	27 ⁷ / ₈ (708)	2021-609-422024	—
	Lateral file Three (3) fixed front drawers	LLFC3Dxxxxx1830xxxx	30 (762)	18 (457)	40 ¹ / ₁₆ (1018)	2031-333-30	—
		LLFC3Dxxxxx2030xxxx	30 (762)	20 (508)	40 ¹ / ₁₆ (1018)	2031-600-302036	—
		LLFC3DFDxxx1836xxxx	36 (914)	18 (457)	40 ¹ / ₁₆ (1018)	2031-333-36	—
		LLFC3DFDxxx2036xxxx	36 (914)	20 (508)	40 ¹ / ₁₆ (1018)	2031-600-362036	—
		LLFC3DFDxxx1842xxxx	42 (1067)	18 (457)	40 ¹ / ₁₆ (1018)	2031-333-42	—
		LLFC3DFDxxx2042xxxx	42 (1067)	20 (508)	40 ¹ / ₁₆ (1018)	2031-600-422036	—

LOCKING LATERAL FILING CABINETS

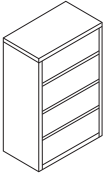
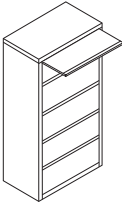
MODEL	DESCRIPTION	GOVERNMENT GoCUIC	WIDTH " (mm)	DEPTH " (mm)	HEIGHT " (mm)	PERFIX CODE	CEILING PRICE \$
	Lateral file Four (4) fixed front drawers	LLFC4Dxxxxx1830xxxx	30 (762)	18 (457)	53 ³ / ₈ (1356)	2041-3333-30	-
		LLFC4Dxxxxx2030xxxx	30 (762)	20 (508)	53 ³ / ₈ (1356)	2041-600-302048	-
		LLFC4DFDxxx1836xxxx	36 (914)	18 (457)	53 ³ / ₈ (1356)	2041-3333-36	-
		LLFC4DFDxxx2036xxxx	36 (914)	20 (508)	53 ³ / ₈ (1356)	2041-600-362048	-
		LLFC4DFDxxx1842xxxx	42 (1067)	18 (457)	53 ³ / ₈ (1356)	2041-3333-42	-
		LLFC4DFDxxx2042xxxx	42 (1067)	20 (508)	53 ³ / ₈ (1356)	2041-600-422048	-
	Lateral file Five (5) drawers First top drawer - receding front, other 4 drawers - fixed front	LLFC5DTRFFx1830xxxx	30 (762)	18 (457)	65 ¹ / ₂ (1664)	2051-13333-30	-
		LLFC5DTRFFx2030xxxx	30 (762)	20 (508)	65 ¹ / ₂ (1664)	2051-600-302060	-
		LLFC5DTRFFx1836xxxx	36 (914)	18 (457)	65 ¹ / ₂ (1664)	2051-13333-36	-
		LLFC5DTRFFx2036xxxx	36 (914)	20 (508)	65 ¹ / ₂ (1664)	2051-600-362060	-
		LLFC5DTRFFx1842xxxx	42 (1067)	18 (457)	65 ¹ / ₂ (1664)	2051-13333-42	-
		LLFC5DTRFFx2042xxxx	42 (1067)	20 (508)	65 ¹ / ₂ (1664)	2051-600-422060	-

LOCKING VERTICAL FILING CABINETS

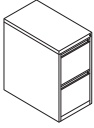
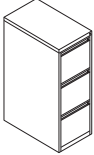
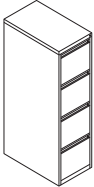
MODEL	DESCRIPTION	GOVERNMENT GoCUIC	WIDTH " (mm)	DEPTH " (mm)	HEIGHT " (mm)	PERFIX CODE	CEILING PRICE \$
	Vertical file Two (2) drawers	LVFC2Dxxxxx2818xxxx	18 (457)	28 (711)	27 ⁷ / ₈ (708)	99 VF 27-18	—
	Vertical file Three (3) drawers	LVFC3Dxxxxx2818xxxx	18 (457)	28 (711)	40 ¹ / ₁₆ (1018)	99 VF 40-18	—
	Vertical file Four (4) drawers	LVFC4Dxxxxx2818xxxx	18 (457)	28 (711)	53 ³ / ₈ (1356)	99 VF 53-18	—

PERSONAL STORAGE TOWERS

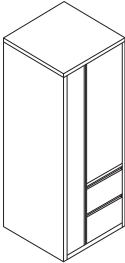
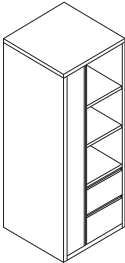

(R = wardrobe at right)

(L= wardrobe at left)

MODEL	DESCRIPTION	GOVERNMENT GoCUIC	WIDTH " (mm)	DEPTH " (mm)	HEIGHT " (mm)	PERFIX CODE	CEILING PRICE \$
	Wardrobe one side 2 file drawers at bottom and closed cupboard above, with lock	PSTxW2FCxxx2424Rxxx	24 (610)	24 (610)	53 ³ / ₈ (1356)	6R-02-242448	—
		PSTxW2FCxxx2424Lxxx	24 (610)	24 (610)	53 ³ / ₈ (1356)	6L-02-242448	—
		PSTxW2FCxxx2430Rxxx	30 (762)	24 (610)	53 ³ / ₈ (1356)	6R-02-302448	—
		PSTxW2FCxxx2430Lxxx	30 (762)	24 (610)	53 ³ / ₈ (1356)	6L-02-302448	—
		PSTxW2FCxxx2436Rxxx	36 (914)	24 (610)	53 ³ / ₈ (1356)	6R-02-362448	—
		PSTxW2FCxxx2436Lxxx	36 (914)	24 (610)	53 ³ / ₈ (1356)	6L-02-362448	—
		PSTxW2DLxxx2424Rxxx	24 (610)	24 (610)	66 (1676)	6R-02-242466	—
		PSTxW2DLxxx2424Lxxx	24 (610)	24 (610)	66 (1676)	6L-02-242466	—
		PSTxW2DLxxx2430Rxxx	30 (762)	24 (610)	66 (1676)	6R-02-302466	—
		PSTxW2DLxxx2430Lxxx	30 (762)	24 (610)	66 (1676)	6L-02-302466	—
		PSTxW2DLxxx2436Rxxx	36 (914)	24 (610)	66 (1676)	6R-02-362466	—
		PSTxW2DLxxx2436Lxxx	36 (914)	24 (610)	66 (1676)	6L-02-362466	—
	Wardrobe one side 2 file drawers at bottom and open cupboard above	PSTxW2FO54x2424Rxxx	24 (610)	24 (610)	53 ³ / ₈ (1356)	61R-02-242448	—
		PSTxW2FO54x2424Lxxx	24 (610)	24 (610)	53 ³ / ₈ (1356)	61L-02-242448	—
		PSTxW2FO54x2430Rxxx	30 (762)	24 (610)	53 ³ / ₈ (1356)	61R-02-302448	—
		PSTxW2FO54x2430Lxxx	30 (762)	24 (610)	53 ³ / ₈ (1356)	61L-02-302448	—
		PSTxW2FO54x2436Rxxx	36 (914)	24 (610)	53 ³ / ₈ (1356)	61R-02-362448	—
		PSTxW2FO54x2436Lxxx	36 (914)	24 (610)	53 ³ / ₈ (1356)	61L-02-362448	—
		PSTxW2FO66x2424Rxxx	24 (610)	24 (610)	66 (1676)	61R-02-242466	—
		PSTxW2FO66x2424Lxxx	24 (610)	24 (610)	66 (1676)	61L-02-242466	—
		PSTxW2FO66x2430Rxxx	30 (762)	24 (610)	66 (1676)	61R-02-302466	—
		PSTxW2FO66x2430Lxxx	30 (762)	24 (610)	66 (1676)	61L-02-302466	—
		PSTxW2FO66x2436Rxxx	36 (914)	24 (610)	66 (1676)	61R-02-362466	—
		PSTxW2FO66x2436Lxxx	36 (914)	24 (610)	66 (1676)	61L-02-362466	—

PEDESTALS

(ON CASTERS)

MODEL	DESCRIPTION	GOVERNMENT GoCUIC	WIDTH " (mm)	DEPTH " (mm)	HEIGHT " (mm)	PERFIX CODE	CEILING PRICE \$
	Mobile pedestal Box-Box-File Locking casters Depth 24" or 30" work surface	PEDSWS22xxxBBFxxxxxx	15 (381)	22 (559)	26 ⁷ / ₈ (683)	40-21-152223-27L	—
		PEDSMLC24xxxBBFxxxxxx	15 (381)	24 (610)	26 ⁷ / ₈ (683)	40-21-152423-27L	—
		PEDSWS28xxxBBFxxxxxx	15 (381)	28 (711)	26 ⁷ / ₈ (683)	40-21-152823-27L	—
		PEDSMLC30xxxBBFxxxxxx	15 (381)	30 (762)	26 ⁷ / ₈ (683)	40-21-153023-27L	—
	Mobile pedestal File-File Locking casters Depth 24" or 30" work surface	PEDSMCL22xxFFxxxxxx	15 (381)	22 (559)	26 ⁷ / ₈ (683)	40-02-152223-27L	—
		PEDSMLC24xxFFxxxxxx	15 (381)	24 (610)	26 ⁷ / ₈ (683)	40-02-152423-27L	—
		PEDSMCL28xxFFxxxxxx	15 (381)	28 (711)	26 ⁷ / ₈ (683)	40-02-152823-27L	—
		PEDSMLC30xxFFxxxxxx	15 (381)	30 (762)	26 ⁷ / ₈ (683)	40-02-153023-27L	—
	Mobile pedestal Box-File Cushion seat locking casters Depth 24" or 30" work surface	PEDSMCLC22xBFxxxxxx	15 (381)	22 (559)	21 ¹ / ₂ (546)	40-11-152221-L	—
		PEDSMCLC24xBFxxxxxx	15 (381)	24 (610)	21 ¹ / ₂ (546)	40-11-152421-L	—
		PEDSMCLC28xBFxxxxxx	15 (381)	28 (711)	21 ¹ / ₂ (546)	40-11-152821-L	—
		PEDSMCLC30xBFxxxxxx	15 (381)	30 (762)	21 ¹ / ₂ (546)	40-11-153021	—

PEDESTALS
(ON GLIDES)

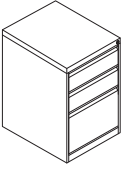
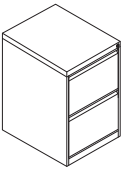
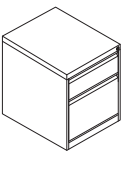
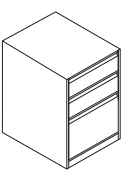
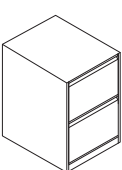
MODEL	DESCRIPTION	GOVERNMENT GoCUIC	WIDTH " (mm)	DEPTH " (mm)	HEIGHT " (mm)	PERFIX CODE	CEILING PRICE \$
	Freestanding pedestal Box-Box-File Depth 24" or 30" work surface	PEDSFSD22xxBBFxxxxx	15 (381)	22 (559)	26 ⁷ / ₈ (683)	41-21-152223-27	-
		PEDSFSD24xxBBFxxxxx	15 (381)	24 (610)	26 ⁷ / ₈ (683)	41-21-152423-27	-
		PEDSFSD28xxBBFxxxxx	15 (381)	28 (711)	26 ⁷ / ₈ (683)	41-21-152823-27	-
		PEDSFSD30xxBBFxxxxx	15 (381)	30 (762)	26 ⁷ / ₈ (683)	41-21-153023-27	-
	Freestanding pedestal File-File Depth 24" or 30" work surface	PEDSFSD22xxFFxxxxxx	15 (381)	22 (559)	26 ⁷ / ₈ (683)	41-02-152223-27	-
		PEDSFSD24xxFFxxxxxx	15 (381)	24 (610)	26 ⁷ / ₈ (683)	41-02-152423-27	-
		PEDSFSD28xxFFxxxxxx	15 (381)	28 (711)	26 ⁷ / ₈ (683)	41-02-152823-27	-
		PEDSFSD30xxFFxxxxxx	15 (381)	30 (762)	26 ⁷ / ₈ (683)	41-02-153023-27	-
	Freestanding pedestal Box-File Depth 24" or 30" work surface	PEDSFSD22xxBFxxxxxx	15 (381)	22 (559)	21 ¹ / ₂ (546)	41-11-152221-27	-
		PEDSFSD24xxBFxxxxxx	15 (381)	24 (610)	21 ¹ / ₂ (546)	41-11-152421	-
		PEDSFSD28xxBFxxxxxx	15 (381)	28 (711)	21 ¹ / ₂ (546)	41-11-152823-27	-
		PEDSFSD30xxBFxxxxxx	15 (381)	30 (762)	21 ¹ / ₂ (546)	41-11-153023-27	-
	Work surface supporting pedestal Box-Box-File Depth 24" or 30" work surface	PEDSWS22xxxBBFxxxxx	15 (381)	22 (559)	27 ⁷ / ₈ (699)	41-21-152224	-
		PEDSWS24xxxBBFxxxxx	15 (381)	24 (610)	27 ⁷ / ₈ (699)	41-21-152424	-
		PEDSWS28xxxBBFxxxxx	15 (381)	28 (711)	27 ⁷ / ₈ (699)	41-21-152824	-
		PEDSWS30xxxBBFxxxxx	15 (381)	30 (762)	27 ⁷ / ₈ (699)	41-21-153024	-
	Work surface supporting pedestal File-File Depth 24" or 30" work surface	PEDSWS22xxxFFxxxxx	15 (381)	22 (559)	27 ⁷ / ₈ (699)	41-02-152224	-
		PEDSWS24xxxFFxxxxx	15 (381)	24 (610)	27 ⁷ / ₈ (699)	41-02-152424	-
		PEDSWS28xxxFFxxxxx	15 (381)	28 (711)	27 ⁷ / ₈ (699)	41-02-152824	-
		PEDSWS30xxxFFxxxxx	15 (381)	30 (762)	27 ⁷ / ₈ (699)	41-02-153024	-

JANUARY 18, 2016



PERFIX INC.

HEAD OFFICE - SHOWROOM - PLANT :

645, Cure-Boivin blvd, Boisbriand, Qc, Canada J7G 2J2 • Tel.: 450-435-0540 • Email: sales@perfix.ca

www.perfix.ca